

# Nikkiso Clean Energy and Industrial Gases Group

Hydrogen Energy Edition – July 2022



Photo: First Element Fuel – 1,200 kg/day H<sub>2</sub> Fueling Station

**NIKKISO**

# Table of Contents

## Hydrogen Energy Edition

04

Radar Map

05

We Know Hydrogen

06

Global Hydrogen Hubs

07

Capabilities

08

Nikkiso Hydrogen Value Chain

10

Nikkiso Clean Energy & Industrial Gases  
Worldwide Locations

12

Products/Pumps – Nikkiso ACD

16

Products/Pumps – Nikkiso Expander Application  
Technology (NEAT)

17

Products/Hydrogen Liquefiers – Nikkiso Cosmodyne

18

Products/Dream it. Design it. Build it.

20

Products/Nikkiso Cryo

24

Products/Heat Exchangers – Nikkiso Cryoquip

26

Product Solutions/Tatsuno Hydrogen Dispensers

27

Product Solutions/Hydrogen Fueling Station

29

New Hydrogen Products & Upcoming Development

31

We Handle the Pressure of Going Green

32

Summary of Scopes

33

Services Offered

34

Aftermarket Services

35

Long-Term Service Agreements

# Nikkiso Clean Energy & Industrial Gases Group

Nikkiso CE&IG's vision statement "Leading the Change to a Healthier World" represents what we want to accomplish as a group. We are dedicated to reducing carbon emissions and leading this valiant effort. Our commitment to Clean Energy and our heritage to Industrial Gases is in synergy with our mission statement. "We provide innovative equipment, technologies, and services through our global group of companies to help our customers make a difference." Our goal is to attain net-zero carbon and contribute to every part of the hydrogen value supply chain, to help create the demand and quickly build infrastructure.

Our role in this growing hydrogen economy is to integrate equipment systems and services, enabling clean energy generation, storage, distribution and consumption to be efficient and reliable. We strive to achieve this through innovation by focusing on new product development, design-build-delivery solutions for our customers and partnering with other OEMs, industry associations and regulatory policymakers. We are only successful if our customers are successful. Our customers have a vision of what they aspire to accomplish. If our total solutions help them make a difference in this world, we become the leaders of that change.

Peter Wagner  
CEO

## Vision

Leading the change to a healthier world

## Mission

We provide innovative equipment, technologies and services through our global group of companies to help our customers to make a difference.

## About Us

Nikkiso's Clean Energy & Industrial Gases Group (CE&IG) is part of the Nikkiso Co., Ltd group of companies. Nikkiso Co. is a \$1.4B public company. CE&IG comprises five distinct functional units: Cryogenic Pumps (ACD, Nikkiso Cryo), Process Systems (Cosmodyne), Heat Exchanger Systems (Cryoquip), Cryogenic Services (through 20 global facilities) and Integrated Cryogenic Solutions (providing centralized management of products and project development). In 2020, CE&IG expanded our capabilities further with the acquisition of what was GP-Strategies' Alternative Fuels Division. This addition provides yet another major manufacturing facility in Southern California. Acknowledged as a market leader in the design, engineering, manufacturing, construction and maintenance of Cryogenic infrastructure, this facility offers full in-house capabilities from engineering & permitting through manufacturing, construction and maintenance.

For over 50 years, we have been a leader in the Clean Energy industry and are leading the change to a healthier world. With our hydrogen filling technology, Nikkiso has become a leader in the evolving hydrogen revolution, including a project on the world's first LH<sub>2</sub> bunkering facility. For more information visit [www.NikkisoCEIG.com](http://www.NikkisoCEIG.com).

# Radar Map

## Overview

This hydrogen brochure is organized according to the Radar Map below. As always, our customer's needs and wants are the core of our business. We strive to meet those needs through manufacturing,

supplying standard and engineered equipment, packaged systems, turnkey and integrated solutions and offering comprehensive and global service.

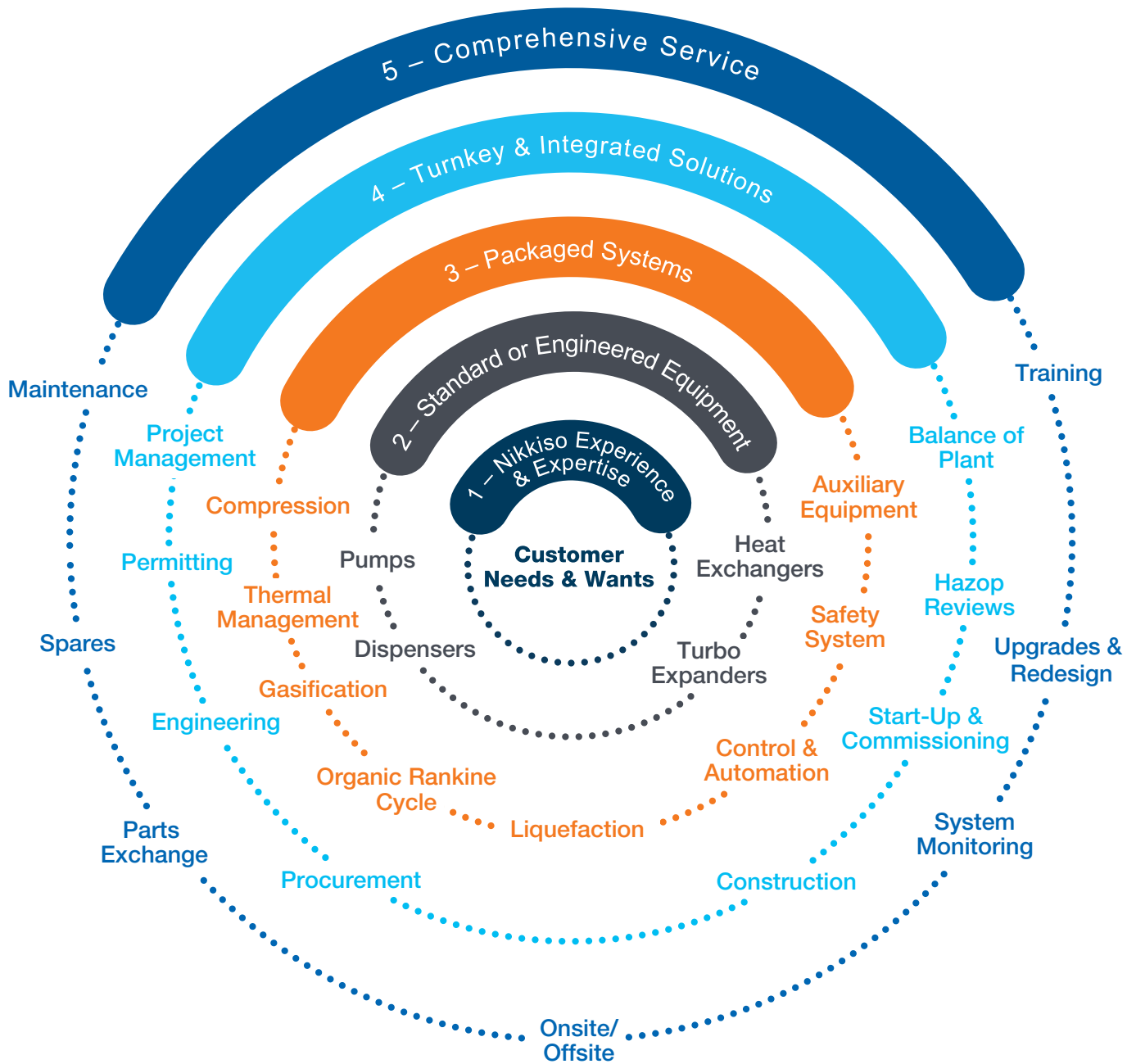

# We Know Hydrogen



1,200 kg/day hydrogen fueling station with 2 dispensers and 4 fueling positions  
Photo: First Element Fuel

For over 30 years, we have been a leader in the hydrogen revolution. We will actively pursue the goals of reaching 200 light-duty H<sub>2</sub> stations by 2025 and a minimum of 200 heavy duty stations by 2035.

- Built over 400 pumps for liquid hydrogen service
- Built over 100 vaporizers & heat exchangers for hydrogen service
- Built 10 hydrogen fueling stations in US
- Over 50 years of cryogenic experience

We design, build, deliver next generation hydrogen fueling stations.

Our operating range is what sets us apart. With the capability to deliver hydrogen at 1,000 kg/hr and 1,000 bar, we allow economical scalability for future stations.

We're able to do this because Nikkiso ACD has traditionally built very high-pressure high-flow equipment that our competitors have not. And, we've adapted that architecture to hydrogen, which allows us to bring those high flows and pressures to the market very quickly.

We continually focus on research and development, increasing the efficiency and operating hours of our pumps. With our new sealing technology that's been in development, we can drive the efficiency of our pumps to the maximum theoretically possible limits.

## Hydrogen Fueling Options

- H<sub>2</sub> is stored in vehicles in gaseous state.
- cH<sub>2</sub> to cH<sub>2</sub> – Uses compressors to pressurize low pressure H<sub>2</sub> gas into high pressure H<sub>2</sub> gas.
- LH<sub>2</sub> to cH<sub>2</sub> – Uses pumps to pressurize low pressure LH<sub>2</sub> liquid up to high pressure and send it through a vaporizer where it is heated and vaporized into a high-pressure H<sub>2</sub> gas. H<sub>2</sub> is stored in vehicles in gaseous state.
- sLH<sub>2</sub> to sLH<sub>2</sub> – Uses pumps to take low pressure LH<sub>2</sub> and through a moderate pressure increase subcool it. H<sub>2</sub> is stored in vehicles in subcooled liquid state.



LH<sub>2</sub> = Liquid hydrogen

cGH<sub>2</sub> = Compressed gas hydrogen

sLH<sub>2</sub> = Subcooled liquid hydrogen

# Global Hydrogen Hubs

Marine applications of Nissiko CE&IG products has been a major focus of the Nissiko CE&IG Group. Our pumps are made in the United States, but our growth and expansion in both Asia and Europe allows us to provide localized engineering, testing and service. This platform allows us to offer complete systems and serve our customers with factory supported solutions, while providing a strong support structure for future growth.

## Asia

Hydrogen demand is key for Korea, China and all of the Asian shipbuilding industry. Our commitment to this growth can be seen by the expansion of our Busan Korea facility to accommodate a new Marine Center. With this expansion, we have become one of the largest manufacturers providing localized assembly in both Busan Korea and Hangzhou China.

The new, larger facility provides full-system marine solutions, and will serve as our Group's home base for all marine activities in Korea. As a unified Nissiko facility, we are the only company that offers the core technology components completely in-house. We provide fully integrated turnkey fuel system solutions, cargo handling solutions and complex LNG missions. We will provide marine solutions including the manufacture and fabrication of cryogenic pumps, FGSS vaporizer skid, LH<sub>2</sub> station skids, process skids, and will feature the latest LN<sub>2</sub> pump skid test facility. It also includes a 342 square meter service center.

Located ideally within the region we can support our key customers and provide anticipated growth of the marine industry's focus on clean energy. The locations also eliminate the need for ocean freighting for shipment delivery, resulting in shorter delivery times to our customers.

Our Hangzhou China facilities are now equipped to manufacture and deliver marine skids and provide full integration and assembly in-house. This allows for greater quality control and reduced cost for our customers. They can now offer in-country full string testing and provide full fuel gasket testing to ensure meeting engine requirements. Together, these facilities now provide full localization for design, engineering and manufacturing.



Busan, South Korea

## Europe

As a result of environmental as well as political considerations, securing and diversifying the supply of energy is currently one of the highest priorities for Europe. Significant investments are devoted to directing the development of the related technologies and infrastructures for production, storage, conditioning, distribution, and use.

The transition to alternative fuels started with the development of Liquefied Natural Gas (LNG), where Nissiko Clean Energy & Industrial Gases (NCEIG) is an active leader supplying Cryogenic pumps and process equipment. This continues with hydrogen seeing an amazingly large application range in spite that mobility and power generation get the most visibility.

To accompany this pioneering move to a sustainable and healthier world, Nissiko Clean Energy & Industrial Gases heavily invests in Europe, settling headquarters in a 2022-commissioned building located in Neuenburg, Germany to host all the functional units under one umbrella. The idea is to promote our H<sub>2</sub> ecosystem with best customer support and hydrogen value chain coverage as shown in the present brochure.

This H<sub>2</sub> ecosystem aims to be the backbone of the regional sustainable hydrogen hubs which are the cornerstone of the European infrastructure. It covers bunkering, liquefaction, pumping, conditioning, distribution and a strong service network.

We multiplied our manufacturing surfaces as well as our project engineering resources to offer highly localized equipment and services as well as packaged solutions, ranging from a bare pump to a turnkey facility, fulfilling the regional requirements.

With decades of experience in cryogenics and LNG, and several hundred pumps running in hydrogen service, we know how critical reliability, cutting-edge performance and state-of-the-art technologies are when developing new innovative applications. Our R&D Center of Excellence for pumps is also located there.



Neuenburg am Rhein, Germany

# Capabilities

Our Integrated Cryogenic Solutions Unit was created to provide a central point of contact for multi-product and multi-tiered projects. Under the umbrella of our ICS division, the Escondido facility allows us to offer the following:

- Complete system and site design with In-house registered professional engineers
  - Specialty system fabrication (including vacuum jacket piping)
  - UL-508 control panel design, fabrication and programming
  - Turnkey construction in North America
  - System installation and maintenance
  - Permitting in North America
  - 24 hour maintenance services
  - ASME pressure vessel repair and alterations
  - In-house HAZOP
  - Cryogenic system design, integration, fabrication and installation
  - Fleet management capabilities
- Completed over 150 projects in North America, including more than a dozen LNG stations built and supported for fleet management



## Ambassador member of the CaFCP







Nikkiso Clean Energy & Industrial Gases Group is proud to be an Ambassador member of the CaFCP. California is on the forefront of the hydrogen movement deploying fuel cell electric vehicles and hydrogen fuel stations. The association is driving to establish 200 hydrogen fuel stations by 2025 for a sustainable future for zero emission cars, trucks and buses. Joining the CaFCP is part of the Group's commitment to leading the change to a healthier world.



# Nikkiso Hydrogen Value Chain

From turnkey solutions to integration, components and service... Nikkiso has you covered every step of the way.

### MAP KEY:

-  Turnkey Solutions
-  Service (All Products)
-  Liquefier
-  Centrifugal Pump
-  Reciprocating Pump
-  Vaporizer
-  Turbo Expander

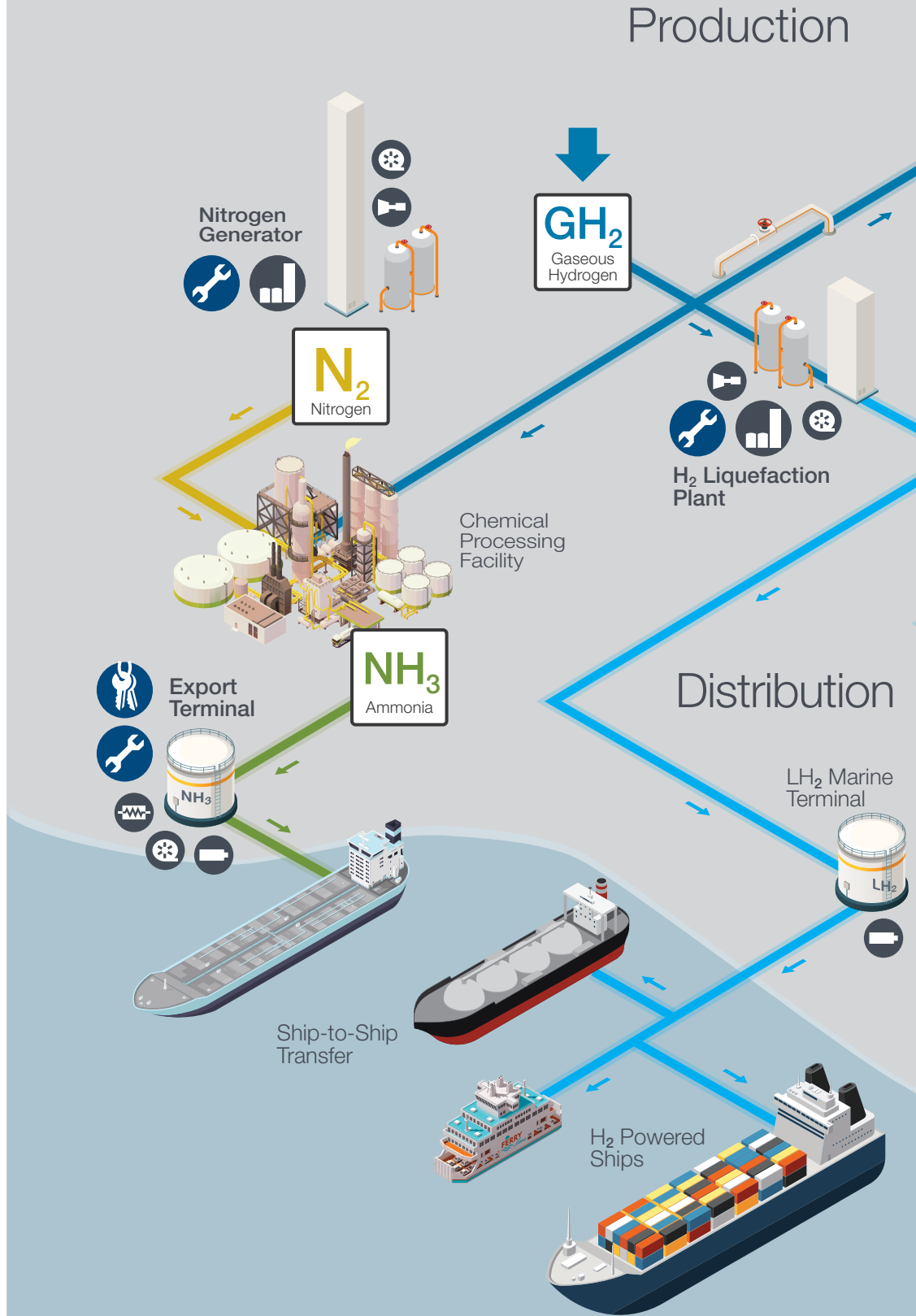



# Consumption

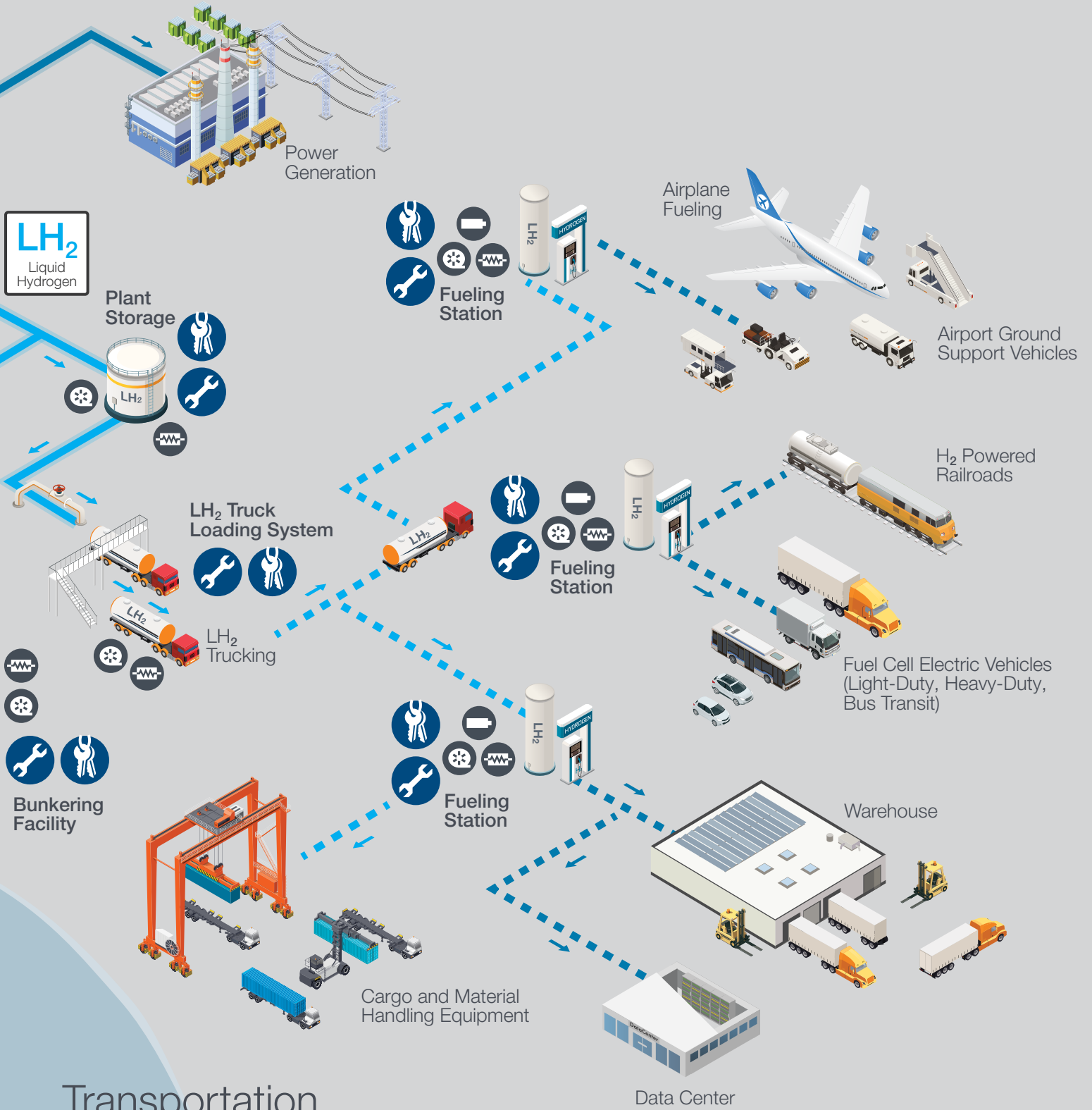

# Transportation

# Nikkiso Clean Energy & Industrial Gases Worldwide Locations



# ations

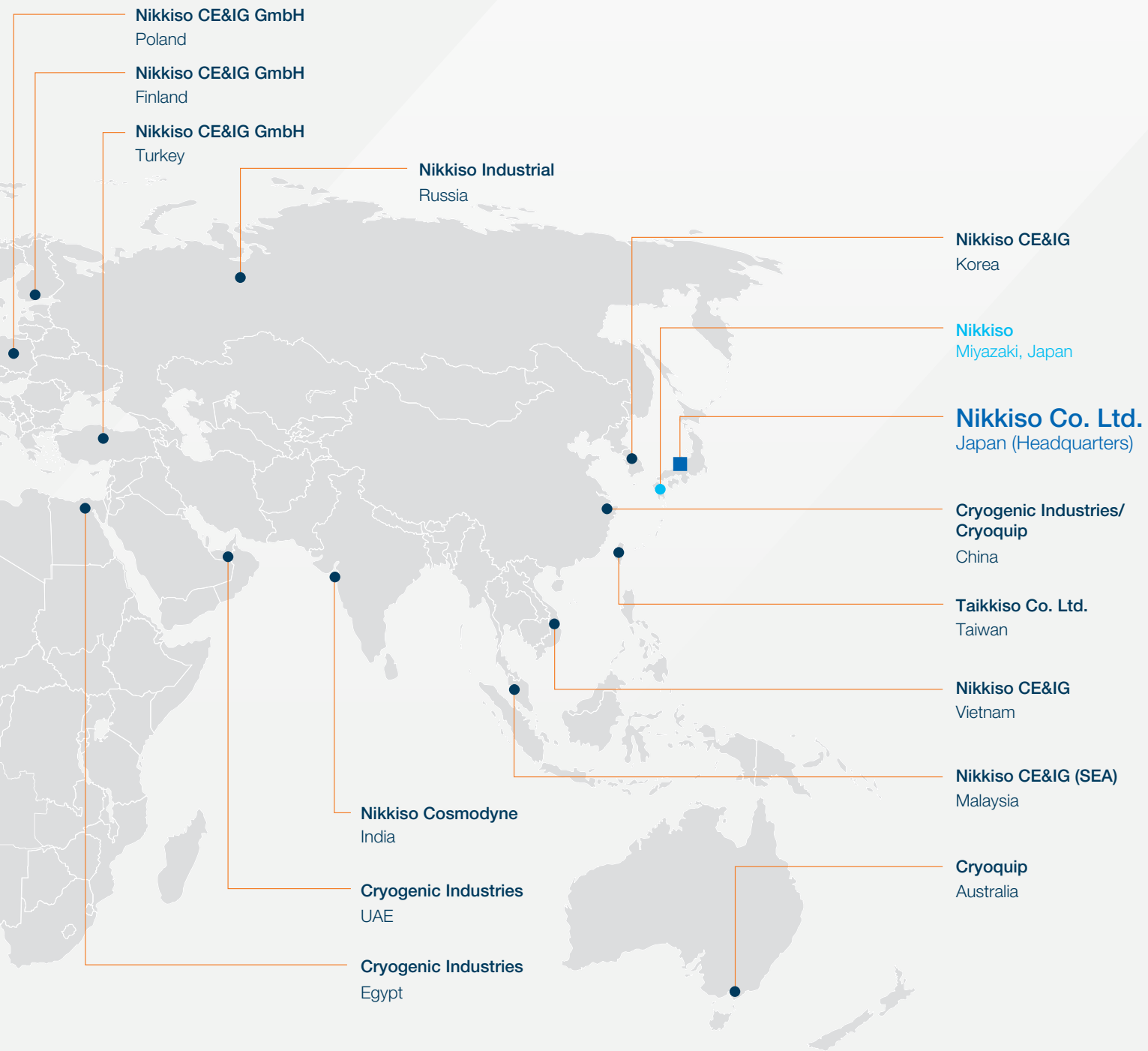

# Products

## Pumps – Nikkiso ACD

### Model TC-34.2

State-of-the-Art Submerged Motor Pumps



**Suction Pot Mounted  
Installation**



**In-tank and Removable  
Installations**

#### Specifications

Flow Range	gpm	1 – 1,600
	lpm	4 – 6,056
	LH <sub>2</sub> kg/hr	15 – 25,000
NPSHR	feet	0.5 – 5
	meter	0.15 – 1.5
Differential Head	feet	50 – 4,000
	meter	15 – 1,220
Pump Design Rating	hp	3.35 – 335
	kw	2.5 – 250
Speed Range	rpm	2,000 – 10,000

Consult ACD engineering for actual performance ratings.

#### Features & Benefits

- Active thrust balancing system for extended bearing life
- High-efficiency hydraulics with extremely low NPSHR inducer
- Light weight and compact
- Available in sump and in-tank designs
- Special design VFD drive provides operation point control over the entire pump operating range
- Features a quick electrical disconnect for ease of maintenance
- All parts from wrought aluminum are precision machined
- Vacuum jacketed sump
- Heavy-duty ceramic bearings

#### Applications

- Fuel supply systems for rail locomotives
- Low-pressure marine fuel systems
- HP Booster pump
- Liquid storage transfer
- Bunkering operations
- Peak-shaving
- Trailer loading and off-loading
- High-pressure pipeline injection
- Power generation

#### Complete Pumping System

- High-efficiency submerged pump
- Vacuum jacketed sump
- Custom made VFD drive – factory string tested
- Dual electrical feed thru hermetically sealed up to 500A

#### Optional Accessories

- Differential pressure gauge
- Loss of prime detector (cavitation protection)
- Safety relief valve
- Dual conduit box per NFPA standards for LNG services
- Complete removal systems
- Long term storage container

# Products

## Pumps – Nikkiso ACD

### Model MP-100

Fuel Station/Storage Filling/Special Application Pump

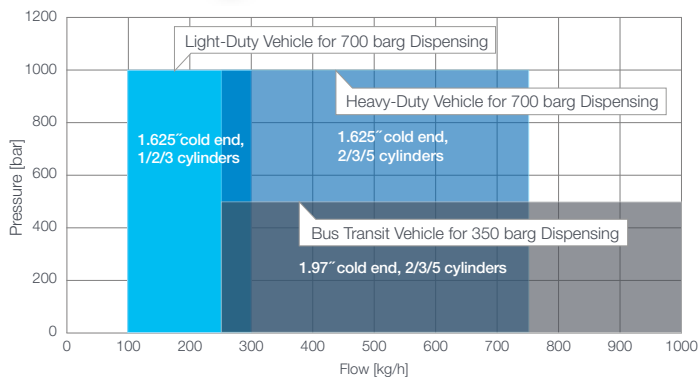

### Specifications

	in	1.625 x 2.25	1.97 x 2.25
	Bore x Stroke (single cylinder)	mm	41 x 57
Flow Rate	gpm	2.6 – 51.5	3.8 – 75.7
	lpm	9.7 – 195.2	14.3 – 286.9
	LH <sub>2</sub> kg/hr	30 – 600	40 – 1,000
Pump Design Rating	hp	15 – 500	15 – 450
	kw	11 – 373	11 – 336
Maximum Discharge Pressure	psi	13,000	8,000
	bar	900	550
NPSPR	psi	5 – 15	5 – 10
	bar	0.35 – 1.0	0.35 – 0.70
Speed Range	rpm	150 – 600	150 – 600

Consult Nikkiso ACD engineering to confirm available sizes and ratings.

900 bar applications require a booster pump (TC-34.2 or reciprocating booster).  
500 barg applications do not require a booster.

### Features & Benefits

- Modular, compact displacement pumps available in 1, 2, 3 or 5 cylinder configurations provide a wide range of flows
- Vacuum jacketed cold end for minimal cool-down losses and economical operation, ideal for liquid hydrogen
- Pressurized oil lubricated drive with integral oil pump and reservoir, allows higher bearing loads/prevent oil leakage
- Compatible with external oil cooler or lube system for continuous duty applications
- State-of-the-art internal sealing design for high efficiency and minimized losses
- Equipment is rated for hazardous locations

### Applications

- Storage filling
- Special medium to heavy-duty applications
- Continuous duty applications
- LH<sub>2</sub> fueling station applications
- Light duty vehicle fueling
- Bus fueling
- HD truck fueling

### Typical Scope of Supply

- Vacuum jacketed cold end with pressure oil lubricated drive end
- Vacuum jacketed suction adapter provides integrated bayonet design
- Distance piece with purge ports
- Hot dipped galvanized steel skid
- TEFC motor
- High-pressure relief valve with discharge line and surge chamber
- Drip pan kit for LH<sub>2</sub> applications
- Suction/vapor return manifold for multiple cylinder configurations

# Products

## Pumps – Nikkiso ACD

### Variable Phase Turbine & Liquid Expander Turbine

Our latest Variable Phase Turbine (VPT) features a patented design that efficiently handles liquid, vapor or any combination during operation. No other product currently available on the market is capable of withstanding two phase fluids without breaking or damage.

The VPT's flashing liquid expander technology offers significant improvements in liquid production while reducing the impact of vapor in the system. This is applicable to the two most popular liquefaction processes—APCI and ConocoPhillips liquefaction processes on the LNG mainstream or the MR refrigeration stream. In addition, it can replace the JT valve in any application, including H<sub>2</sub> liquefaction.

This product enhances targeted reduction in carbon emissions, an increase in liquid production, and reduction in vapor generation. It also provides further reduction in the downstream pressure and down tank pressure in APCI process.

This turbine represents a significant step toward the reduction of emissions while at the same time offering cost savings to our customers. Proven tests have shown that return on customer's investment can be achieved within 6-12 months, a significant value long term for customers.



# Products

## Pumps – Nikkiso ACD

### Linear Drive Technology Reciprocating Pumps

sLH<sub>2</sub> fueling stations, booster applications

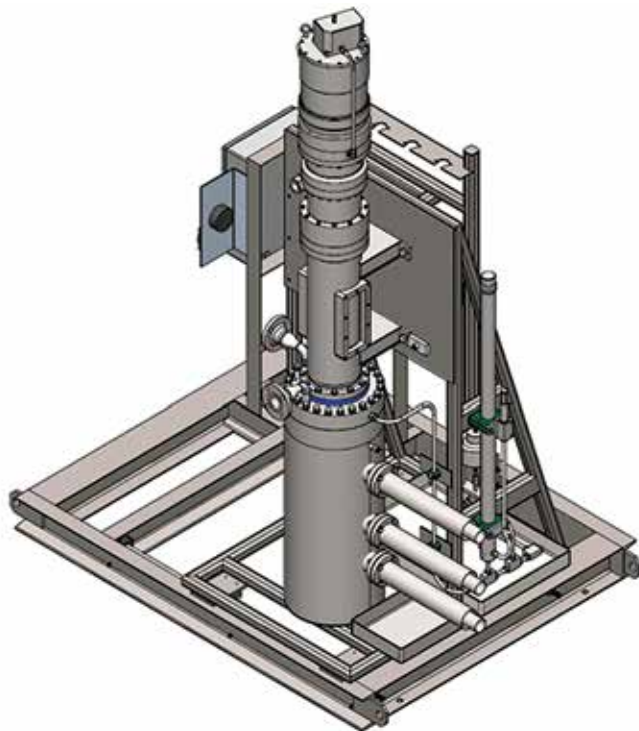

#### Features & Benefits

Nikkiso Linear Drive Reciprocating Pump Technology is perfectly suited to this sLH<sub>2</sub> and Booster applications due to inherently high hydraulic efficiency. As the pump brings the LH<sub>2</sub> up to the desired output pressure, heat input to the fluid is minimized when subcooling of the fluid is maximized.

The linear drive system combined with the vertical orientation offers less vibration, reduced noise, and a compact system footprint. The pump is provided with an external oil conditioning system that ensures maximum drive life and the ability to keep the pump cooled and ready to operate for extended periods of time. The vertical cold end is submerged inside a vacuum-jacketed sump, minimizing heat leak and increasing system efficiency. The control system is provided with the pump for easy integration and simplified regulation of output flow.

The cryogenic fluid end of the pump operates while constantly submerged in LH<sub>2</sub> within a vacuum jacketed sump for minimal atmospheric heat ingress. Furthermore, the special routing of the vapor losses and their intentional separation from the routing of the discharge flow further reduces heat input and enhances the subcooling of the LH<sub>2</sub> supplied to the vehicle. The drive of the pump is a specialized Nikkiso electromechanical linear actuator that allows for a wide range of adjustments to pump operating characteristics for the optimization of pump performance under a varied and diverse set of operating points. The unit is managed by the fueling station control system.

#### Applications

- sLH<sub>2</sub> Fueling Stations
- Booster Applications

#### Operating Range

Flow: Up to 1,000 kg/hr  
Pressure: Up to 3 MPa

# Products

## Pumps – Nikkiso Expander Application Technology (NEAT)

### Turbo Expander Liquefaction

The most common hydrogen liquefiers operate with Claude/Reverse Turbo-Brayton Cycle. This cycle utilizes cold expander to minimize J-T load.

An expander-compressor is available with conventional oil bearings and active magnetic bearings. The expander-compressor with active magnetic bearing is a totally oil free turbomachine with small footprint.

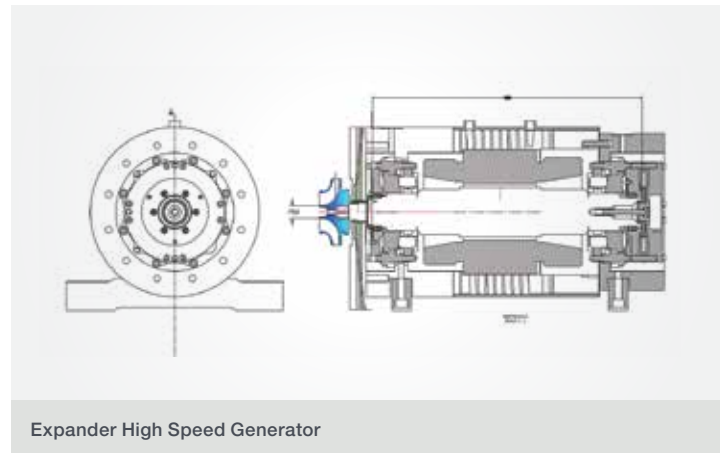
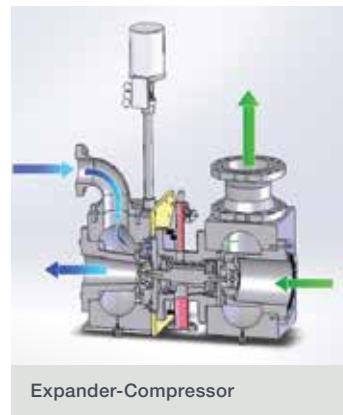
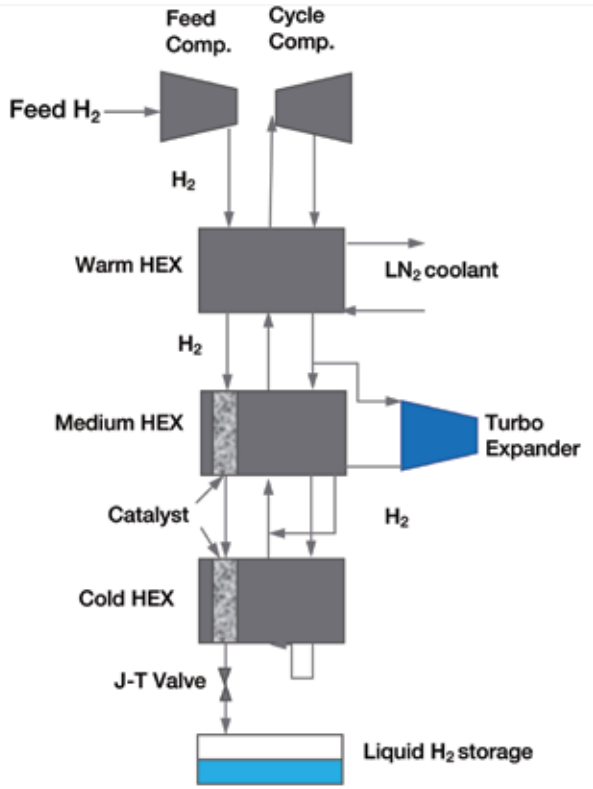

Nikkiso expanders are with high efficiency and configured as expander-compressor and expander-integral gear generator.

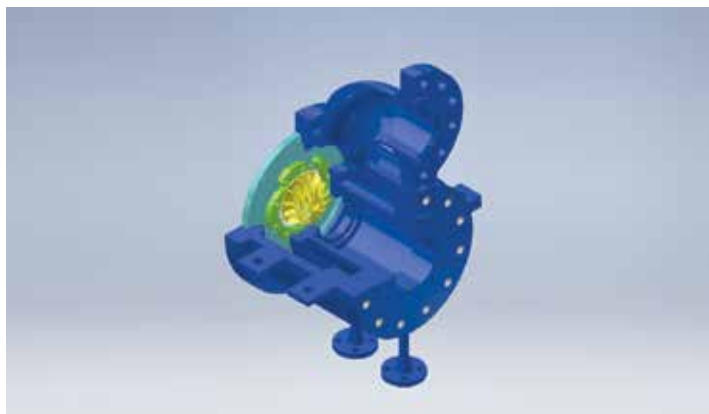



# Products

## Hydrogen Liquefiers – Nikkiso Cosmodyne



### Features & Benefits

- Over 60 years of cryogenic liquefaction design experience and over 450 cryogenic installations world-wide
- Pretreatment for different hydrogen feed stream sources
- In-house turboexpander design
- Small footprint, modular system for economic shipping and installation
- Liquefaction systems from 5 to 15 mTPD

# Products

Dream it. Design it. Build it.

## TC 34.2 Sump

### Complete Liquid Hydrogen Bunkering Installation



Crowds gather to learn about this revolutionary future fuels technology

Nikkiso CE&IG is proud to be working to develop solutions for the future, particularly regarding LH<sub>2</sub>.

Continuing our commitment to lead the change to a healthier world, we partnered with clean energy solutions company Unitrove to lay the groundwork for zero-emissions marine fueling infrastructure at ports throughout the world. The first ever Liquid Hydrogen (LH<sub>2</sub>) Bunkering Solution was showcased at the COP26 Climate Change Conference in Glasgow (November 2021). This project is just one example of our drive toward more energy-efficient solutions for the Marine market.

We provided custom equipment from two of our Functional Units: a sump from our Heat Exchangers unit (Cryoquip) and Cryogenic Pumps unit (ACD).



Nikkiso sump

# Products

Dream it. Design it. Build it.

## Nikkiso ACD's first Hydrogen Mobile Refueler Pump



Mark Geipel, Ricardo Garcia Manzo AL and Jose Cervantes

**Dream it. Design it. Build it.**

Nikkiso ACD is proud to present the first hydrogen mobile refueler pump skid design by Mark Geipel and his team of engineers.

The synergy of exceptional sales and leadership, brilliant engineers, along with expert shop technicians sets us up for success not only today, but for the exciting technological/clean energy initiatives of the future.

## Nikkiso Cryoquip – Australia Liquid Hydrogen Systems



LH<sub>2</sub> Pressure Decant Skid

During 2019, Kawasaki Heavy Industries built a Liquid Hydrogen Plant in Hastings, Victoria, Australia, approximately 45 minutes from the Nikkiso Cryoquip facility in Melbourne.

Nikkiso Cryoquip Australia built over USD 2.5M in hydrogen, liquid hydrogen and liquid nitrogen systems for this plant. Nikkiso Cryoquip has recently upgraded their LH<sub>2</sub> pressure decant skid.

In order to effectively fuel the LH<sub>2</sub> ship, a purpose built pressure decant skid, designed by KHI, and built by Cryoquip is employed. It takes LH<sub>2</sub> from a LH<sub>2</sub> ISO container, boils part of the cargo to build pressure in the ISO container in a controlled manner and quickly decant the LH<sub>2</sub> to the ship and minimize gas losses.

The plant was built to provide liquid hydrogen for a “proof of concept” trial of international shipping of liquid hydrogen, between Australia and Japan.

# Products

## Pumps – Nikkiso Cryo

### Submerged Motor Cryogenic Pumps

#### Unmatched Reliability, Quality and Safety

As part of the Nikkiso Company global organization, our “original technologies” provide our customers with the confidence in knowing they are receiving the latest technology and the highest standards of engineering available.

Located in North Las Vegas, Nevada, in the USA, Nikkiso Cryo offers a full range of submerged pumps for LNG, LPG, LEG, LN<sub>2</sub>, liquid propylene and many other liquefied gases.

With design, production and test facilities in both the USA and Japan, sales offices in Las Vegas, Houston, London and Tokyo, Nikkiso Cryo offers prompt and full support for all of our customers worldwide.

#### Specifications

Flow Range	gpm	1 – 1,600
	lpm	4 – 6,056
	LH <sub>2</sub> kg/hr	15 – 25,000
NPSHR	feet	0.5 – 5
	meter	0.15 – 1.5
Differential Head	feet	50 – 4,000
	meter	15 – 1,220
Pump Design Rating	hp	3.35 – 335
	kw	2.5 – 250
Speed Range	rpm	2,000 – 10,000

Consult Nikkiso ACD engineering to confirm available sizes and ratings.



# Products

## Pumps – Nikkiso Cryo

### Removable In-Tank Pumps

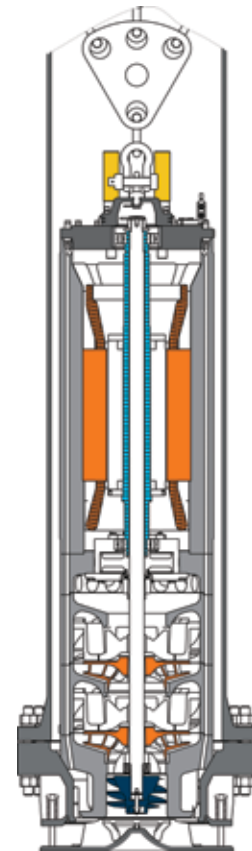

#### Features & Benefits

Removable, or in-tank pumps offer the advantage of overhead removal and installation without taking the tank out of service. The pump operates at the bottom of a purpose-built pump column through which it is installed and removed. The column provides the fluid discharge from the pump to the top of the tank and contains the lifting cables as well as the power cables. Our ZEN (Zero Enabled NPSH) inducer was specially developed to allow the pumps to reduce liquid levels to extremely low levels.

#### Applications

##### Liquefaction & FPSO

- Loading pump
- Recirculating pump
- Reflux pump

##### Regasification & FSRU

- Primary pump
- Emergency pump (FSRU)

#### Scope of Supply

- Pump
- Foot valve
- Lifting & electrical cables
- Head plate
- Feed through, junction box
- Vibration monitoring system

#### Performance Range

Flow: Up to 6,000 M<sup>3</sup>/hr

Differential Head: Up to 9,000 meters

# Products

## Pumps – Nikkiso Cryo

### Suction Vessel Mounted Pumps

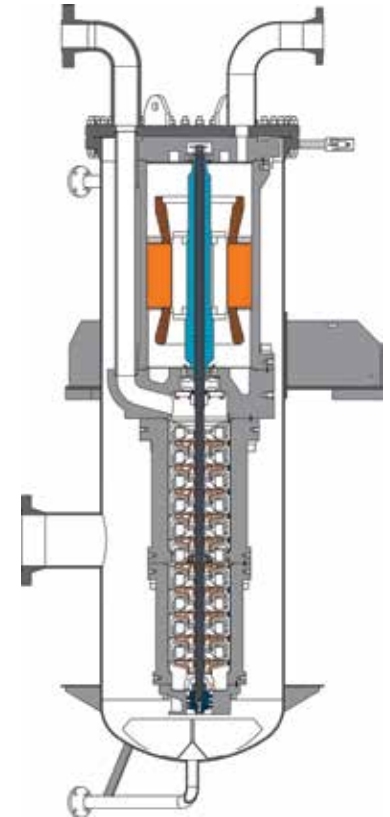

#### Features & Benefits

This design is provided with the pump and suction vessel which becomes an integral part of the piping system with external suction and discharge connections. The pump is mounted to the top or headplate of the vessel such that the pump, motor and fluid product are totally contained within the pressure vessel. Shaft seals are eliminated. The pump inlet is below the suction vessel inlet which allows the source tank liquid levels to be lowered to a minimum.

#### Applications

##### Liquefaction & FPSO

- Transfer pump
- Booster pump

##### Regasification & FSRU

- Send out pump
- Line packing pump

##### Cogeneration

- Turbine Feed pump

##### Vehicle Fueling

- Fueling pump

#### Scope of Supply

- Pump
- Vessel & head plate
- Feed through, junction box
- Vibration monitoring system

#### Performance Range

Flow: Up to 6,000 M<sup>3</sup>/hr

Differential Head: Up to 9,000 meters

# Products

## Pumps – Nikkiso Cryo

### Fixed In-Tank Pumps

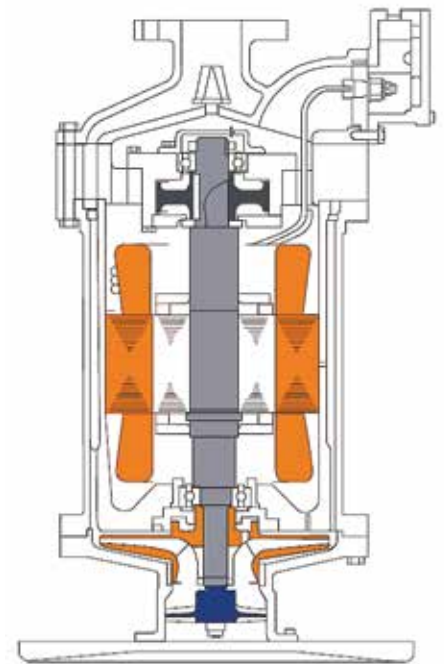

#### Features & Benefits

This pump type is mounted directly to supports in the bottom of a storage tank and connected to a discharge pipe which extends to the top of the tank and out to the discharge piping. This simple and low-cost design is used in liquefied gas carriers and in any other application where removing the liquid from the tank for maintenance is a normal or required process and can be accomplished without excessive costs to the tank or system.

#### Applications

##### Liquefaction & FPSO

- Spray unloading pump (FPSO)

##### Regasification & FSRU

- Unloading pump (FSRU)
- Primary pump (FSRU)

#### Scope of Supply

- Pump
- Feed through, junction box
- Vibration monitoring system

#### Performance Range

Flow: Up to 6,000 M<sup>3</sup>/hr

Differential Head: Up to 9,000 meters

# Products

## Heat Exchangers – Nikkiso Cryoquip

### Ambient Vaporizers

#### Features & Benefits

- Ambient vaporizers represent the most cost-effective equipment to vaporize or re-gasify liquid cryogenes
- Electric vaporizers and trim heaters utilize high quality electric heating elements and stainless steel heat exchanger tubes
- Water bath vaporizers for high volume vaporization and regasification of industrial gases and LH<sub>2</sub>
- Shell-and-tube direct contact vaporizers for high pressure vaporization and regasification of LH<sub>2</sub>



Skidded high pressure ambient vaporizer system



Ambient vaporizers with fog reduction modules



Natural Draft Ambients



Hydrogen sub-cooler with VJ piping and heat exchanger designed to increase efficiencies when pumping



# Products

## Heat Exchangers – Nikkiso Cryoquip

### Water Baths, Vaporizers & Supporting Equipment



Water bath vaporizers with ambient air vaporizer backup option



Electric



LH<sub>2</sub> Loading skid for Liquefaction Plant to Tanker Transfer



Smaller version of the waterbath vaporizer

# Product Solutions

## Tatsuno Hydrogen Dispensers

Nikkiso is an Authorized North America Aftermarket Partner for Tatsuno's Hydrogen Dispensers

### Dispenser – H35/H70

#### Nikkiso's Service Offer:

- New installation
- Commissioning
- Integration with fuel and/or fleet
- Management systems
- Spare parts
- Maintenance service
- Repair services
- Local support in CA

#### Features & Benefits

- ETL Intertek Certification
- SAE 2601, SAE 2799 compliant
- Dual sided design for simultaneous fueling
  - A dual-sided hydrogen dispenser equipped with two nozzles for simultaneous fueling
  - No problem even during the peak of the rush hours
- Fast and smooth operation
  - Equipped with touch panels and payment terminals on both sides
  - Easy and stress-free operation from the arrival to the station to the end of the fueling
- Fueling performance test
  - The dispenser passed a fueling performance test on a HyStEP device in California



### Hydrogen Fuel Stations Configuration Examples

Fuel Cell Vehicles	Type of Fueling (Source – Dispense)	Standards Compliance	Pressure (barg)	Temperature (°C)	Max Pump Flow (kg/hr)	FCEV Capacity (kg)
Light-Duty Passenger Vehicles	LH <sub>2</sub> – cGH <sub>2</sub>	SAE J2601-1 Categories A, B, C & D SAE J2799 SAE J2719	700	minus 40	120	5
					240	45
Heavy-Duty Class 8 Trucks	LH <sub>2</sub> – cGH <sub>2</sub>	SAE J2601-2 J2719	350	minus 40	280	65
			700	minus 40	500	100
			20 – 25	minus 247	500	60
Transit Buses	LH <sub>2</sub> – cGH <sub>2</sub>	CEP Subcooled LH <sub>2</sub> Fueling Process v1.8 CEP Subcooled LH <sub>2</sub> Fueling Interface v1.10 J2719			500	80
			SAE J2601-2 Categories A & B SAE J2799 SAE J2719	350	minus 20	280
Drayage Truck	LH <sub>2</sub> – cGH <sub>2</sub>	SAE J2601-2 J2719	700	minus 20	480	30
Yard Truck						20
Top Handler			350	minus 20	560	40
RTG						60
Custom	LH <sub>2</sub> , cGH <sub>2</sub> , sLH <sub>2</sub>	Per Customer Request	350 or 700	minus 20 or minus 40	up to 1,000	Per Customer Request

\* Include 255 sec wait time in between fills

\*\* Based on target flow achievable by new generation dispenser.

# Hydrogen Fueling Station

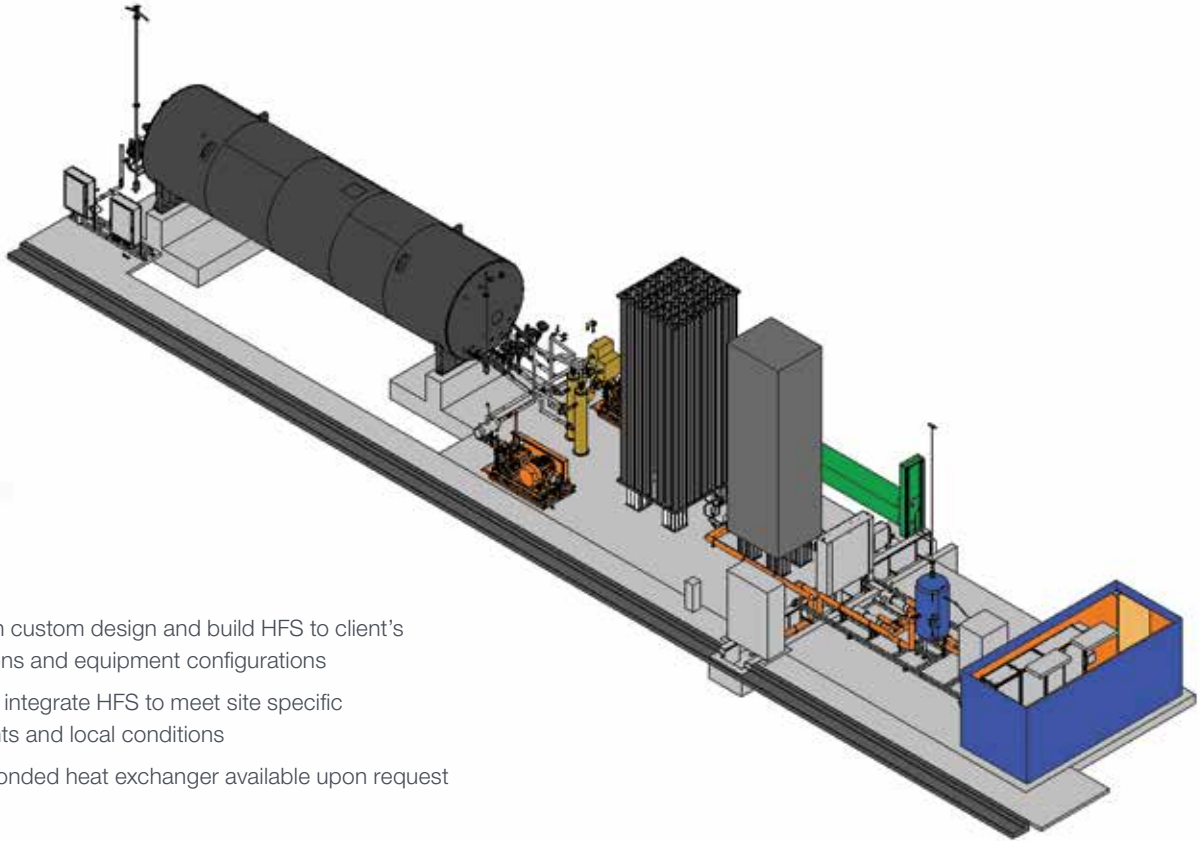

- Nikkiso can custom design and build HFS to client's specifications and equipment configurations
- Nikkiso will integrate HFS to meet site specific requirements and local conditions
- Diffusion bonded heat exchanger available upon request

Station Size (kg/day)	# of FCEV Per Day*	Profile	Centrifugal Booster Pump	Reciprocating Pump	Dispenser	Fueling Positions	Average. Vehicle Flow (kg/min)	Package
808	580	Chevron	Yes	Simplex	1	2	1.0	Containerized
1615	684	Friday	Yes	Simplex (2x) or Duplex	2	4	1.0	Containerized
3,671	82		-	Duplex	2	2	2.3	Skidded
3,887	60	Flat 16 hrs	-	Duplex	2	2	2.3	Skidded
5,908	59		Yes	Quintuplex	1	1	8.3**	Skidded
4,347	72		-	Quintuplex	1	1	6.7**	Skidded
4,726	59	Flat 16 hrs	-	Quintuplex	1	1	6.7**	Skidded
935	25		-	Duplex	1	1	2.5	Skidded
1,684	28	Flat 8 Hrs	-	Duplex	2	2	5**	Skidded
1,870	62		Yes	Duplex (2X)	2	4	2	Skidded
1,684	84		-	Duplex (2X)	2	4	2	Skidded
2,244	56	Flat 5 Hrs	-	Duplex (2X)	2	4	2.3	Skidded
2,403	40		-	Duplex (2X)	2	4	2.3	Skidded
24,000			Contact Nikkiso for optimized solution				1 to 10**	Skidded

# Product Solutions

## Hydrogen Fueling Station

Nikkiso provides total integrated solutions for Hydrogen Fueling Stations. Utilizing our Group's global resources and products, we are able to provide solutions to our customers with the lowest total cost of ownership. We are unique in that many of the critical and proprietary cryogenic products are designed and manufactured within the Nikkiso Cryogenic Industries facilities. Additionally, we utilize our established relationships with key partners, to complement the in-house engineering

and manufacturing capabilities. The result is the total engineering, procurement and fabrication of your project. This ensures the highest quality equipment and guarantees a timely and successful project outcome. With over 50 years' experience in the cryogenic equipment business, we bring together the people, products and experience needed for system integration and single source responsibility.

### Typical Hydrogen Fueling Station

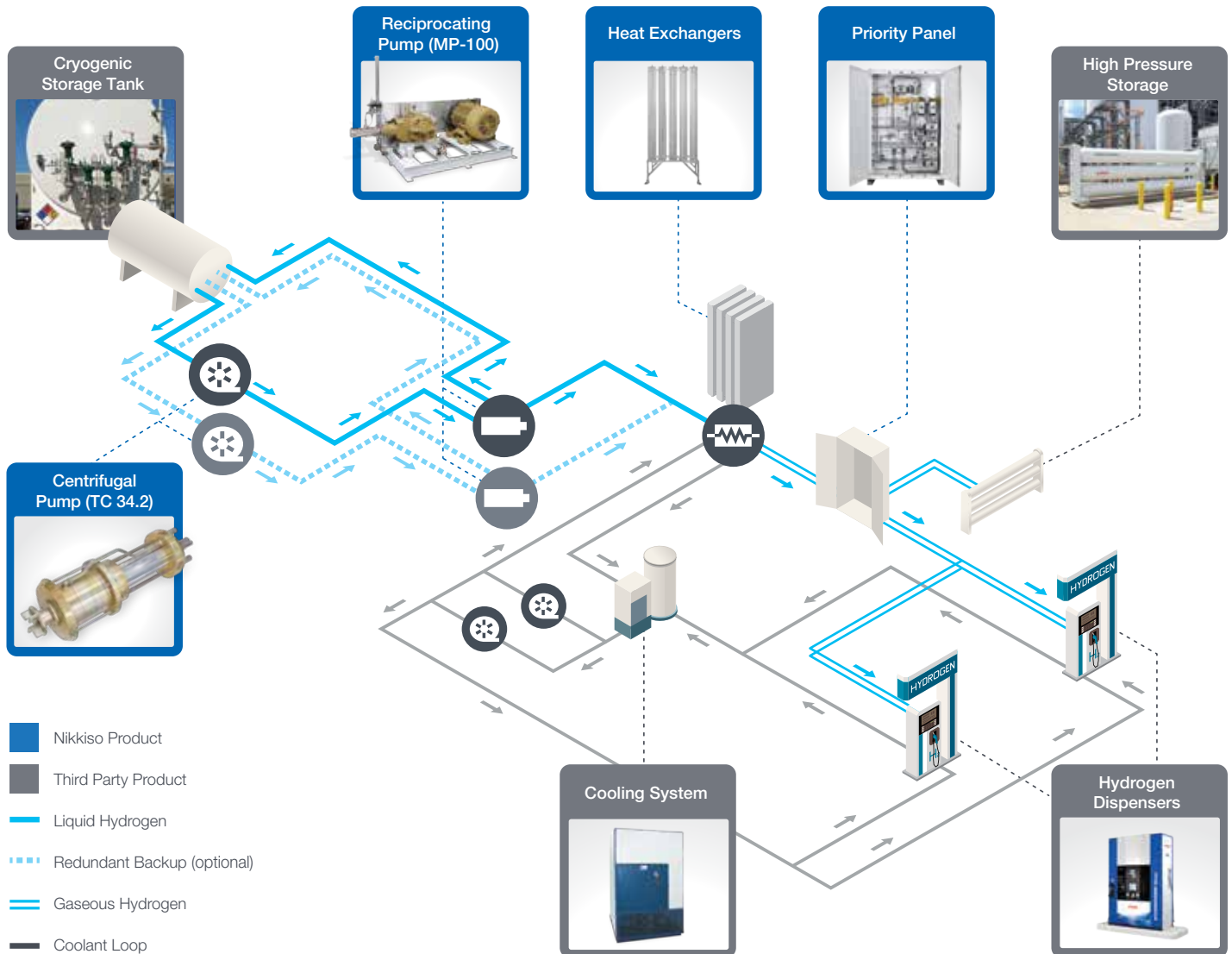

# New Hydrogen Products & Upcoming Development

## Skidded sLH<sub>2</sub> Station

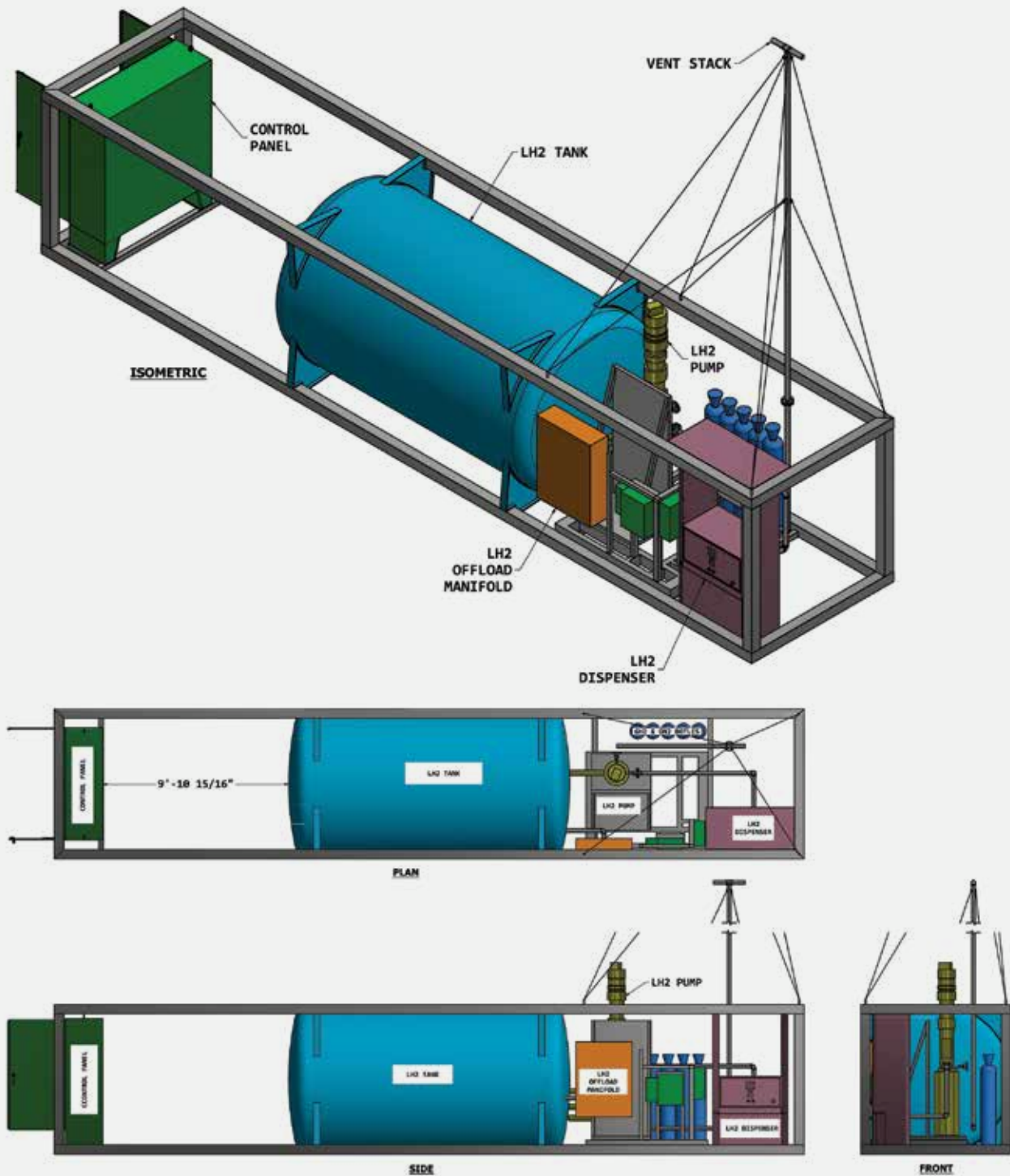

# New Hydrogen Products & Upcoming Development

## Containerized LH<sub>2</sub> Station

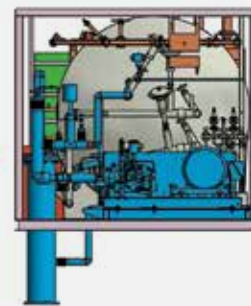
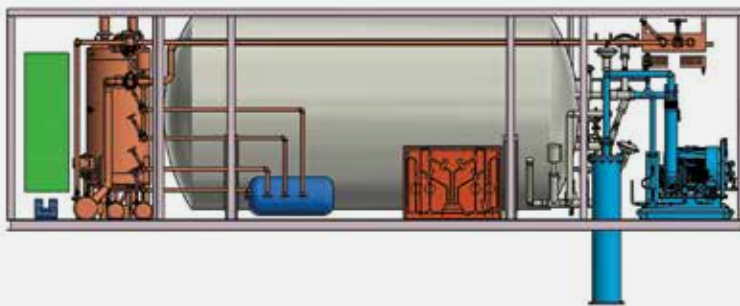
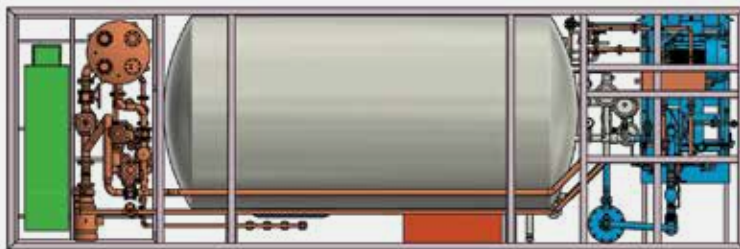
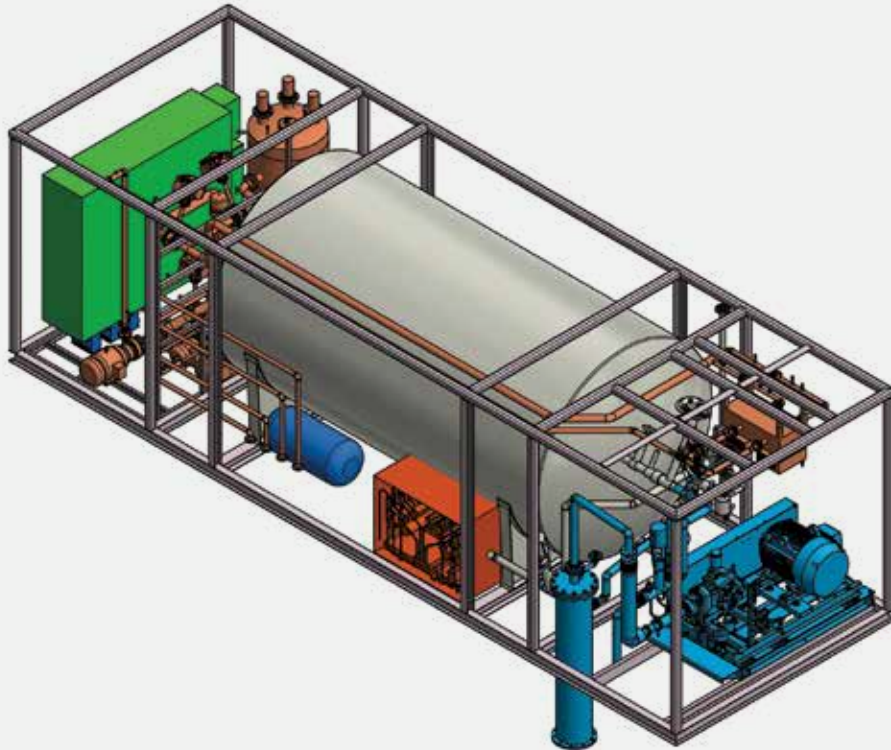

# We Handle the Pressure of Going Green

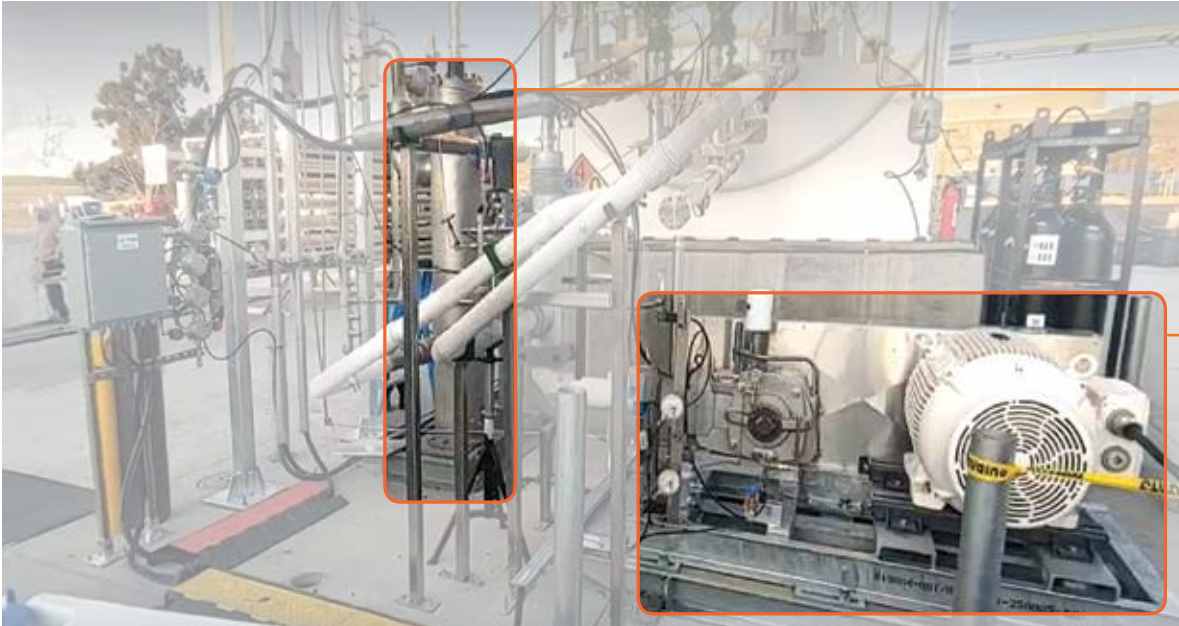

TC-34.2 Stage Centrifugal Pump

MP-100 Simplex Reciprocating Pump



Sunline facility - 1,000 palms

# Summary of Scopes



## Design, Build and Project Delivery

### Project Management

- Scope, cost & schedule management
- Risk management
- Stakeholder coordination & communication
- HFS system integration (inc. balance of plant)
- Regulatory compliance (NFPA 2, NFPA 55 etc.)
- Permitting (grading & building)

### Engineering

- Design package:
  - Process design, control & instrumentation
  - Mechanical & electrical package
  - Civil & structural
- HAZOP/fire safety

### Procurement

- Intercompany transactions (ACD, CQP, ICS)
- 3rd parties (compressor, tank, HP vessels, dispensers)
- Logistics (inc. expediting)
- Spares

### Fabrication

- Equipment skids
- Electrical & control enclosure
- Priority panels
- Interconnecting piping (including VJ) & wiring
- Quality control (including factory acceptance tests)

### Construction

- Contractor & site management
- Site preparation and foundation
- Mechanical & electrical installation
- Facility integration (including utilities, safety system)
- Pre-start safety review

### Commissioning

- Documentation
- Equipment/system start-up
- Quality assurance (including site acceptance tests)
- Training



# Services Offered

Nikkiso Cryogenic Industries Service Companies (NCS) are directly affiliated with cryogenic pump manufacturers Nikkiso ACD and Nikkiso Cryo, the world's leaders in the design and manufacture of cryogenic reciprocating, centrifugal pumps and all branches of turbo expanders for over 65 years. Furthermore, NCS is an authorized service center for Air Liquide Turbo (formerly ACD Turbo).

## Trained Technicians, Rapid Response

A team of highly-qualified and well trained technicians and engineers is supported by the technical expertise and resources of the NIKKISO NCS Engineering group. The advanced engineering support to field service personnel marks the difference between individuals performing a service versus having the full technological team of resources of strong established company behind.

From 20 global service locations, our team of certified technicians provide a broad range of products and services, including:

- Pump & Turbo Expander repair
- Field service and commissioning
- Pump exchange program
- Turbo Expander exchange program
- Testing capabilities
- Product training seminars
- 24/7 customer support from certified technicians.
- Long term service agreements (LTSA)

## Full Machining Capabilities

NCS Service unit provides advanced manufacturing process systems, 5 axis milling machines, quality control and testing expertise for expander components and compressor wheels. Where necessary, the complete rotating element assembly can be manufactured to the customers exacting specifications, tested and ready to be installed.

Facility machine shop includes:

- CNC 5-axis machining
- Engine lathe
- Dynamic balancing per ISO 1940 G2.5

The customer's designs are held in strict confidence and not shared with any other organization or used for any purpose other than provide the contracted services.

## Field Service

Field service capabilities include:

- Start up and commissioning assistance
- Comprehensive problems diagnostics
- Operational and maintenance training of customer's personnel
- Complete equipment evaluation and report



## Aftermarket Services



Your equipment deserves the best attention—from the provision of genuine OEM parts, spare or replacement parts—to our pump and turbo exchange program, regularly scheduled visits, repair, maintenance and product training. All these are provided to reduce your total cost of ownership. The extended lifetime of your equipment depends on it, and Nikkiso Cryogenic Service technicians are here for you at every stage.

Our goal is to provide the best possible aftermarket support for our customers. We do that by continuing to deliver high quality service that allows you to maintain reliable operations and deliver sustainable productivity.

### Aftermarket service

NCS has over 65 years experience providing know-how on equipment, parts and service. With a team of over 75 certified technicians, we stand ready 24/7 to help you keep your equipment running smoothly.



# Long-Term Service Agreements

A long term service agreement should be straightforward and simple. No hidden costs, no confusing language or exceptions.

Our LTSA's are designed to provide full transparency. We also offer set service rate prices on field service work, as well as reduced rates on parts. From day one through the contract's end date, your pricing will remain consistent, allowing for consistent forecasting.

NCS service plans offer on-time servicing by trained field service personnel, along with top quality genuine OEM pump, turbo expander and cartridge spare parts designed to ensure our equipment's top reliability and performance. Regularly scheduled maintenance will let you sleep better at night. We'll work with your team and schedule for your maximum convenience, and minimal disruption. Knowing your parts are being serviced routinely allows for worry-free operations, and more time for you to focus on other important matters, and providing a reduction of total cost of maintenance.

## Benefits

- Reduction of total maintenance cost
- Scheduled, regular service visits
- Protect your machinery with genuine OEM spare parts
- Priority assistance at short notice
- Dedicated inventory
- Eliminate downtime
- Discounted field service rates

To Learn more, contact our customer service team at [info@NikkisClService.com](mailto:info@NikkisClService.com).





Nikkiso Clean Energy & Industrial Gases –  
Ambassador to CaFCP



**Europe**

Ole Skatka Jensen  
Vice President Europe  
CE&IG GmbH

Tel: +49.171.6942.978  
ole.jensen@acd cryo.com

**US**

Henry Hui  
H<sub>2</sub> Director  
Integrated Cryogenic Solutions

Tel: +1.832.707.3482  
hhui@NikkisoSolutions.com

**South Korea**

Jay Lee  
General Manager  
Operations

Tel: +82.51.711.5400  
jaylee@nikkisoceig-korea.com

**Australia and SE Asia**

Timothy Born  
Vice President  
South East Asia

Tel: +61.402.302.251  
tborn@cryoquip.com.au